

Dimensions

SPHQ Enclosure

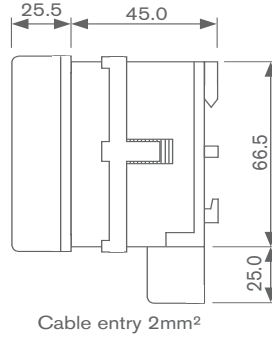

Dimensions for Surface Mounting

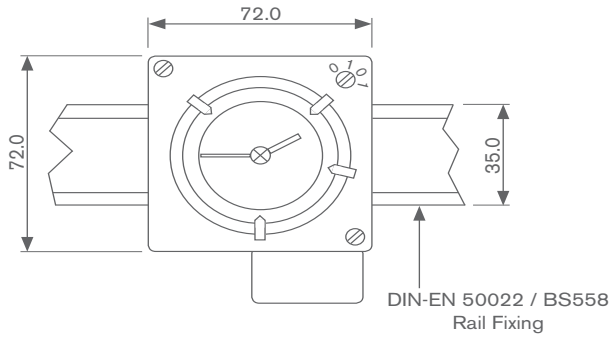
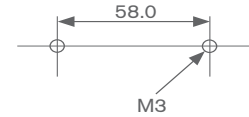

Max. Panel Thickness 10mm
Panel Cutout 66.0mm square (± 1.0 mm)

TM848 Enclosure

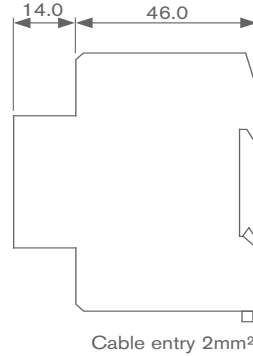
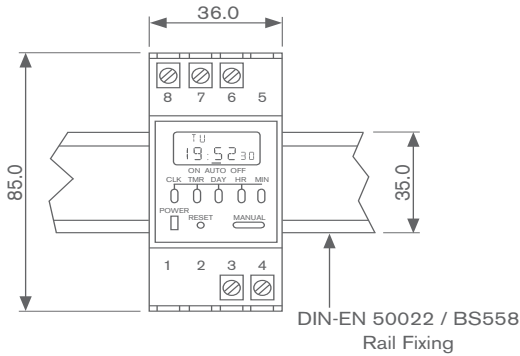

Dimensions for Surface Mounting
Adaptor Plate

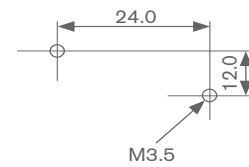

TM812 Enclosure

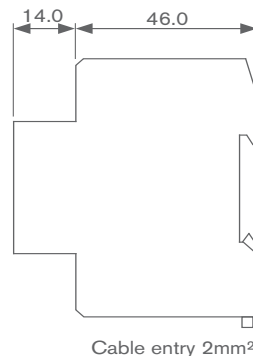
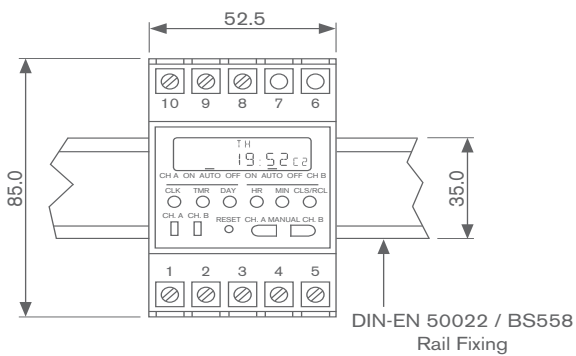

Dimensions for Surface Mounting
Adaptor Plate

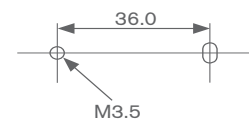

TM823 Enclosure

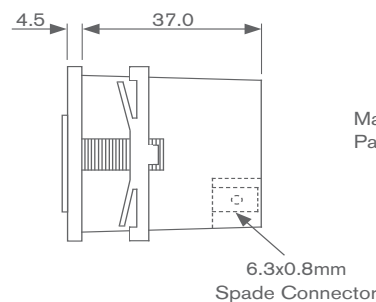
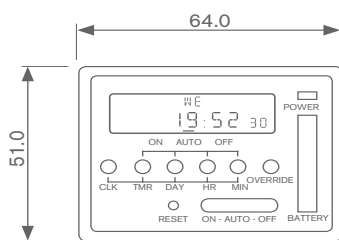

Max. Panel Thickness 10mm
Panel Cutout 60mm x 47.0mm (± 1.0 mm)

All dimensions in mm

Selector Switches



Global Suppliers of Measurement and Protection Equipment for Industry





Voltmeter & Ammeter Switches

Models Available

- C174** 3 Phase 3 Wire Voltmeter Switch
- C176** 3 Phase 4 Wire Voltmeter Switch
- C178** Ammeter Switch

Product Features

- 48mm x 60mm front facia
- Choice of interchangeable legend plates
- 600Vac and 16A rated
- Fingerproof screw clamp terminals

Voltmeter and ammeter selector switches are used to switch between phases for measurement on a three phase system.

Voltmeter selector switches are available to switch between line-line voltage or line-line and line-neutral voltage while the ammeter selector switch switches between the three phase line currents. The output from the switch can then be fed to an analogue or digital measuring instrument.

The switches offer long term switching reliability and high current switching contacts. The switch facia measures 48mm by 60mm and the switch terminals are fingerproof. A wide choice of interchangeable legend plates are available to suit each switch.

For switching between phases to measure 3 phase voltage or current

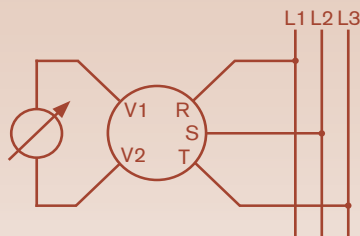

C174 Voltmeter Selector Switch

For connection to a 3 phase 3 wire system.

P53	P54	P55
VOLTMETER O	VOLTMETER OFF	VOLTMETER O
TR RS	BR RY	L3L1 L1L2
ST	YB	L2L3

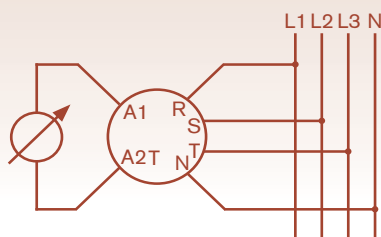

C176 Voltmeter Selector Switch

For connection to a 3 phase 4 wire system.

P56	P57	P58
VOLTMETER OFF	VOLTMETER OFF	VOLTMETER OFF
RS RN	RY RN	L1L2 L1-N
ST SN	YB YN	L2L3 L2-N
TR TN	BR BN	L3L1 L3-N

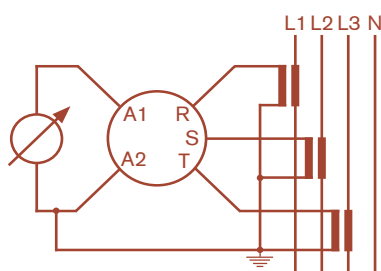

C178 Ammeter Selector Switch

For connection to a 3 phase 3 wire or 3 phase 4 wire system.

P61	P62
AMMETER O	AMMETER O
T R	3 1
S	2
P63	P64
AMMETER OFF	AMMETER O
B R	L3 L1
Y	L2